



**One axes controller for CosmosNet
Control System
CMS-100**

User's manual

MYCOM, INC.

History of change for user's manual

Change	Date of change	Change part	Description of change	Name of changer
A	April 26, 2006	P39	· Current ON and current OFF command are added.	T.NAKATA
B	Sep. 21,2006	P36	Status writing command are added	N.HARUNO

Attention on Safety

Please read this user's manual carefully before using this device.



Warning

Please keep the followings and use safely to avoid a fatal accident.

Do not use or leave it unattended after disassembling or damaging this unit.

The above might cause an electrical shock or an accident. We will not be responsible for repair if the unit is disassembled by the customer.

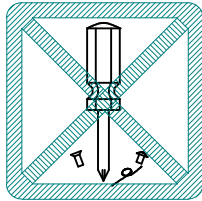

Do not touch the unit with wet hand.

The above might cause electric shock or accidents.

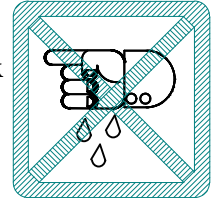

Avoid having metals and other foreign objects enter into the device.

The above might cause fire, electric shock or accidents.

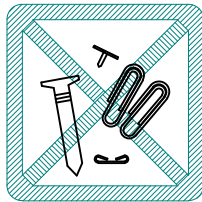

Attention on safety

Please read this user's manual carefully before using this unit.



Attention

Please keep the followings and use safely to avoid an accident.

Do not use or store the unit near by corrosive gas, watery or chemical place.

It may cause fire, electric shock or accident.



Confirm the input voltage and wiring before power on.

Wrong wiring or input voltage may cause fire or accident.

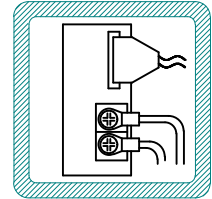

Do not use or store this unit in a place of direct rays of the sun.

It may cause an accident.

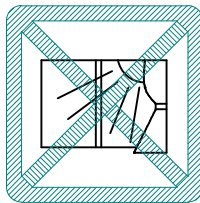

Earth

Earth (D class earth) or connect with protective earth in case of the product having protective earth terminal to avoid electric shock.

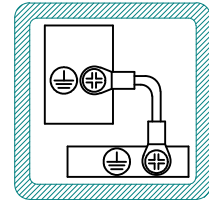

Attention on usage

Please read this user's manual before using this device.



Attention

Please keep the following and use safely to avoid an accident.

Do not use or store this device in a dusty place.

This device is not constructed dustproof. Operating in dusty place causes the accident.



Do not give the device a big shock.

This is a precision device and it should not be dropped or given a big shock. It causes the accident.

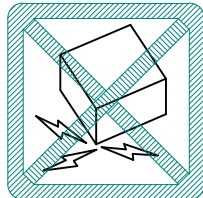

Do not use or store it in a place where the temperature might rise too high or too low.

The operating temperature is 0°~40°C and the storage temperature is 0°~60°C.

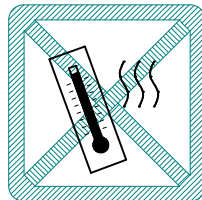

Avoid extreme temperature changes.

Do not use or store it in a place where the humidity might rise too high or too low.

The operating humidity should be within 30% - 80%. The storage humidity should be within 20% - 90%.

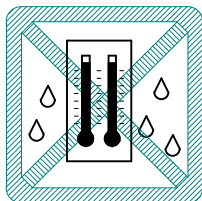

Avoid condensation of dews.

Bringing the device into a place of high humidity or a place where temperature changes suddenly will cause condensation of dews.

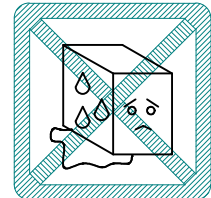

Take measures against noises.

Noises will cause malfunctions and accidents.

Use the power supply which is not connected to a noise generating device.

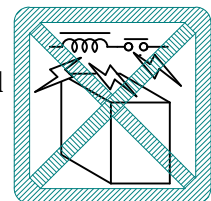

Use shielded wires for wiring. Make them as short as possible. Use the twisted pair wires for the clock outputs.

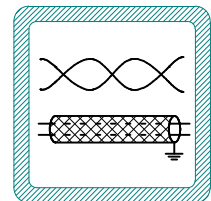

In case of AC type products, separate power cable (AC) from signal line (DC) more than 20cm.

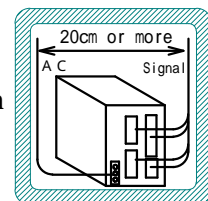

Earth if the products have earth terminal.

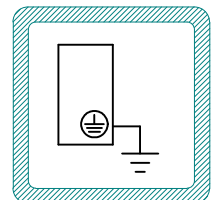

Contents

1. Foreword.....	1
1-1. Checking contents of package.....	1
1-2. Optional accessories	1
2. Specification	2
3. Dimensions	3
4. Connector.....	4
4.1. Connector pin assignment	4
4.1.1. CONTROL Connector	4
4.1.2. SENSOR connector	4
4.1.3. DRIVER connector	5
4.1.4. USB HOST connector.....	6
4.1.5. USB DEVICE connector	6
4.1.6. Power source terminal	7
4.2. Input/output circuit	7
4.3. Description of signal.....	9
4.3.1. Description of CONTROL connector signal.....	9
4.3.2. Description of SENSOR connector signal.....	11
4.3.3. Description of DRIVER connector signal.....	13
4.3.4. Description of USB HOST connector/USB DIVICE connector signal	13
5. Parameter.....	14
5.1. List of parameter (Movement data)	14
5.2. List of parameter (System setting).....	17
6. Function.....	19
6.1. External start.....	19
6.1.1. Timing chart of external signal	19
6.1.2. Movement data selection signal (DSEL0-3)	19
6.1.3. External start signal (ST_HOME, ST_POS, ST_SCAN, ST_JOG).....	20
6.1.4. Movement direction selection signal (DIR)	22
6.1.5. Deceleration / Stop signal (SDOWN, SSTOP, /ES)	23
6.2. USB Communication function.....	24
6.3. Other functions	24
6.3.1. Function change	24
6.3.2. Software limit function	25
7. Example of wiring.....	26
7.1. Wiring example with DRIVER connector	26
7.2. Wiring example for SENSOR connector	26
7.3. Wiring example for CONTROL connector	27

8. List of error code	28
9. Appendix.....	29
9.1. Communication command.....	29
9.1.1. List of command	29
9.1.2. Communication data format.....	29
9.1.3. Description of communication data	30

1. Foreword

Thank you using our CMS-100, one axis controller for COSMOS NET control system, this time.

Please read this manual thoroughly in prior to using this unit and operate this unit correctly.

1-1. Checking contents of package

CMS-100 includes main unit and user's manual. Please check that all of them are included in the package. We are carefully packaging the products but please contact our agencies or us if contents are incomplete.

- Main unit CMS-100
- User's manual This Book

1-2. Optional accessories

There are following optional accessories for CMS-100

- Control software MYCIS II "CMS-100 GUI"
- I/O Connector Set CMS-100-IOCS

2. Specification

The specification of CMS-100 is as follow

Items		Description				
Control system		Microprocessor control system				
Communication type		USB2.0 supporting				
Number of axes controlled		One axis				
Control Motor		Stepping motor				
Program capacity		Moving data	12 different types (Serial EEP-ROM, writing times 10 ⁵)			
Acceleration deceleration system		Trapezoidal or triangle				
Command system		External start signal, Communication command				
External start		Homing, positioning(absolute/relative), Scanning, Jog, Deceleration, Decelerated stop, Emergency stop, Parameter write, Parameter read, Status read, Alarm release				
Start speed and Maximum speed		100/N to 6553500/N(Hz)(N=1 to 256) N=1(100Hz to 6.5535MHz) to N=256(about 0.39Hz to 25.599KHz) (Setting range depends on speed range setting. When N=256, please set 0 at speed range setting.)				
Moving distance setting		Available moving distance setting (-2147483648 pulses to 2147483647 pulses)				
One moving command setting range		-2147483648 pulses to 2147483647 pulses				
Driver I/F		Output for clock (Each one series of Open collector and Line driver) Resolution selection (DIV0 to DIV3), CO, HEAT				
Mechanical sensor I/F		Forward/Reverse over-run, Home				
Exclusive I/O		Input	12 points	Photo coupler isolated 5mA internal power source (+24V) used External start signal (Homing, Positioning, Scanning, Jog) Deceleration and stop signal (Deceleration, Decelerated stop, Emergency s top) Position specified signal(DSEL0 to DSEL3) Direction signal (DIR)		
		Output	2 points	Photo coupler isolated Open collector output, 10mA, Less than dielectric strength 35V Error output(ERR), Ready output(RDY)		
Parameter function		Systems setting (Moving data for homing, Soft limit, resolution, Speed range setting, Function selection) Moving data setting (Position data, Start speed, Maximum speed, Acceleration slope, Deceleration slope)				
Input power		AC100 to AC220V				
Environment (without condensation)		Operating	Temperature	0 to 45 deg C 32 to 113 deg F	Humidity	30 - 80%
		Storing		0 to 60 deg C 32 to 140 deg F		20 - 90%
Dimension		35(W) x 126(D) x 165(H)mm (excluding protuberance)				
Weight		525g				

3. Dimensions

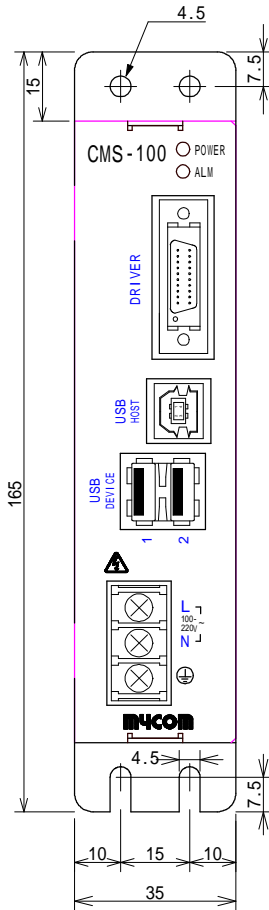

Frontview

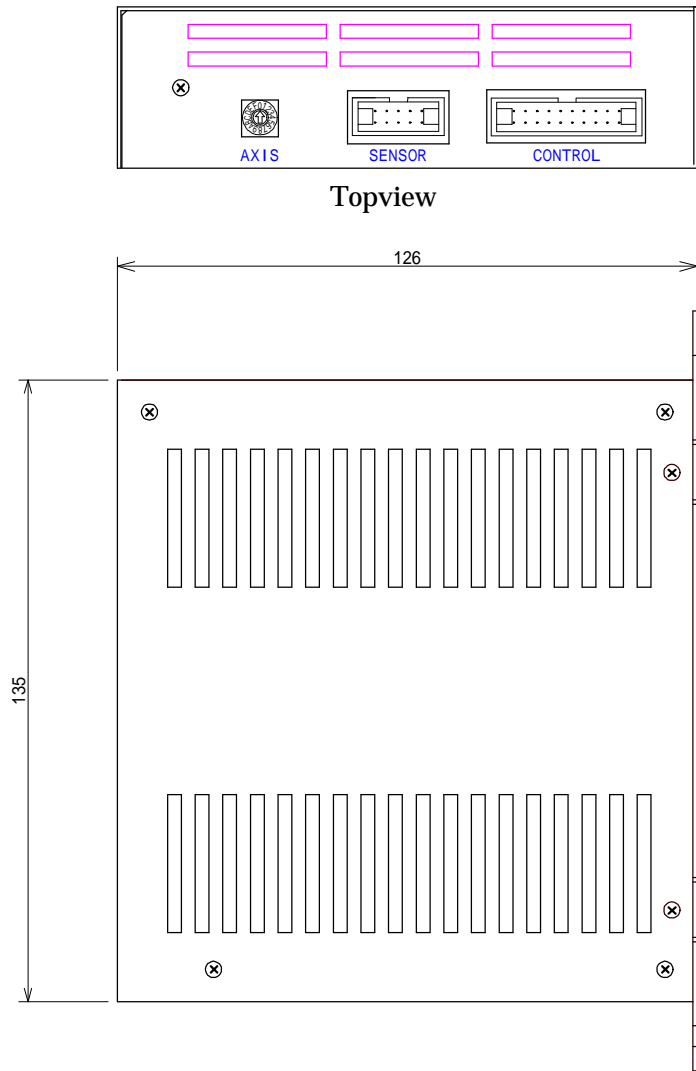

Sideview

Unit:mm

4. Connector

4.1. Connector pin assignment

4.1.1. CONTROL Connector

Item	Model number	Brand
Plug	XG4C-2034	Omron
Socket	XG4M-2030	

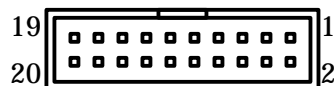

Pin	Signal	Description	I/O	circuit
1	+COM(24V)	+ common for RDY, ALARM	-	-
2				
3	RDY	Ready for command/On moving signal	Output	Circuit 1
4	ALM	Abnormal monitor signal		
5	NC	Not used	-	-
6				
7	DSEL0	Moving data selection signal	Input	Circuit 2
8	DSEL1			
9	DSEL2			
10	DSEL3			
11	ST_HOME	Homing start signal		
12	ST_POS	Starting of Position data moving		
13	ST_SCAN	Starting of Scanning		
14	ST_JOG	Starting of jog		
15	DIR	Direction signal		
16	SDOWN	Deceleration signal		
17	SSTOP	Deceleration stop signal		
18	/ES	Emergency stop signal(Remark 1)		
19	-COM(0V)	-common for input signal	-	-
20				

Remark 1: Please use with the status of normal close (B connection), when normal operating. Please connect with -COM(0V) terminal if it is not used. If this unit is not the status of normal close, this unit does not work.

4.1.2. SENSOR connector

Item	Model number	Brand
Plug	XG4C-1034	Omron
Socket	XG4M-1030	

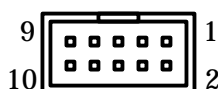

Pin	Signal name	Description	I/O	Circuit
1	HOME	Home sensor signal	Input	Circuit 2
2	FOR	Limit sensor signal of forward direction		
3	REV	Limit sensor signal of reverse direction		
4	NC	Not used	-	-
5				
6				
7				
8				
9				
10	-COM(0V)	-Common for HOME, FOR, REV	-	-

4.1.3. DRIVER connector

Item	Model number	Brand
Right angle connector	PCS-E20LMD	Honda
Flat cable connector	PCS-E20FC	
Connector case	PCS-E20LT	

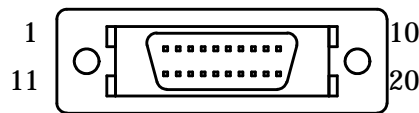

Pin	Signal	Description	I/O	Circuit
1	CW+	CW clock output	Output	Circuit 3
2	CW-	(Clock output in case of 1 clock setting)		
3	CCW+	CCW clock output		
4	CCW-	(Direction output in case of 1 clock setting)		Circuit 4
5	RSCW+	CW clock output (Line driver)		
6	RSCW-	(Clock output in case of 1 clock setting)		
7	RSCCW+	CCW clock output(Line driver)		Circuit 5
8	RSCCW-	(Direction output in case of 1 clock setting)		
9	CO+	Current-off output		Circuit 6
10	CO-			
11	DIV0	Output of resolution selection		
12	DIV1			
13	DIV2			
14	DIV3			
15	+COM(5V)	+common(5V)	-	-
16	NC	Not used	-	-
17				
18				
19	HEAT		Input	Circuit 7
20	-COM(0V)	-	-	-

4.1.4. USB HOST connector

Item	Model number	Brand
Socket B type	XM7B-0422	Omron

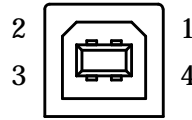

Pin	Signal	Description
1	VBUS	USB power pin
2	D-	USB data signal
3	D+	
4	GND	USB power pin

4.1.5. USB DEVICE connector

Item	Model number	Brand
Socket A type	XM7B-0422	Omron

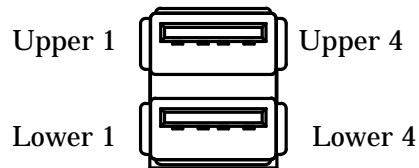

Pin	Signal	Description
Upper 1	VBUS	USB Power pin
Upper 1	D-	USB data signal
Upper 3	D+	
Upper 4	GND	USB Power pin
Lower 1	VBUS	USB POWER PIN
Lower 2	D-	USB Data signal
Lower 3	D+	
Lower 4	GND	USB Power pin

4.1.6. Power source terminal

Item	Model number	Brand
Through terminal	W121C-3MC	World

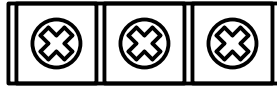

Signal	Description
L	Power terminal
N	
FG	FG terminal

4.2. Input/output circuit

Circuit 1

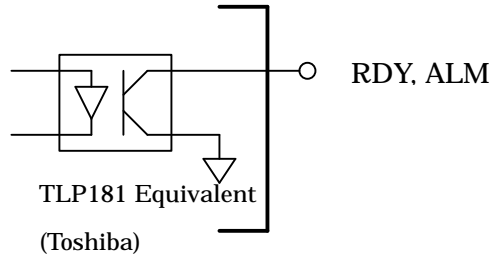

Circuit 2

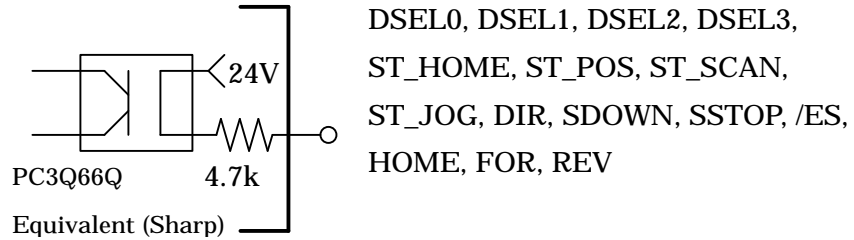

Circuit 3

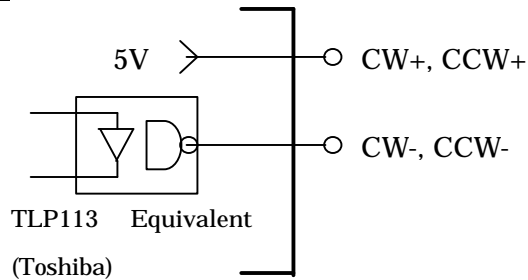

Circuit 4

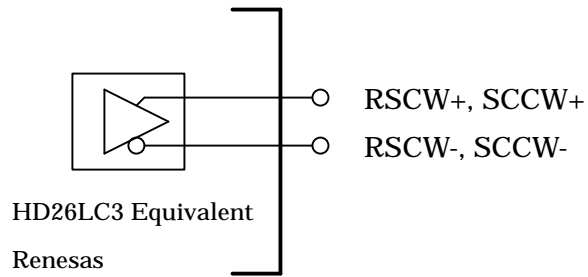

Circuit 5

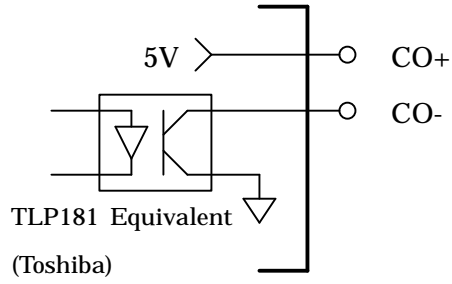

Circuit 6

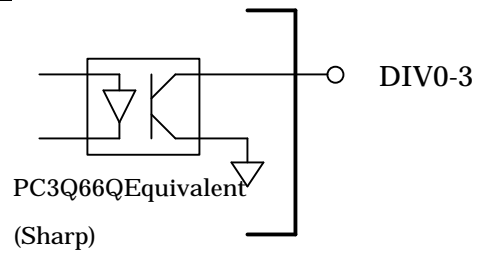

Circuit 7

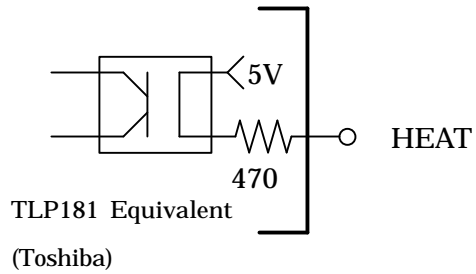

4.3. Description of signal

4.3.1. Description of CONTROL connector signal

4.3.1.1. RDY(Command waiting/Moving signal)

This signal shows active status of CMS-100. This signal is ON when command or start signal is acceptable.

This signal is OFF while communication command or command by external start signal is proceeding or moving.

4.3.1.2. ALM(Abnormal monitor signal)

This signal is output signal which show the abnormal status of CMS-100. In abnormal case, this signal is ON.

When ALM is ON, please release alarm after clearing the abnormal condition.

4.3.1.3. DSEL0-3(Moving data selection signal)

This signal is input signal for selection of moving data. This signal is used for the selection of data for positioning movement, scan movement and jog movement.

signal No.	DSEL3	DSEL2	DSEL1	DSEL0
0	OFF	OFF	OFF	OFF
1	OFF	OFF	OFF	ON
2	OFF	OFF	ON	OFF
3	OFF	OFF	ON	ON
4	OFF	ON	OFF	OFF
5	OFF	ON	OFF	ON
6	OFF	ON	ON	OFF
7	OFF	ON	ON	ON
8	ON	OFF	OFF	OFF
9	ON	OFF	OFF	ON
10	ON	OFF	ON	OFF
11	ON	OFF	ON	ON
12	ON	ON	OFF	OFF
13	ON	ON	OFF	ON
14	ON	ON	ON	OFF
Sequential start	ON	ON	ON	ON

4.3.1.4. ST_HOME(Homing start signal)

This signal is input signal for homing start. When this signal becomes ON, homing is executed by the data of homing movement of system setting.

4.3.1.5. ST_POS(Positioning movement start signal)

This is input signal for positioning movement start signal. When this signal goes ON, positioning movement is executed by selected movement data of DSEL0-3(Moving data selection signal)

4.3.1.6. ST_SCAN(Scan movement start signal)

This is input signal for scanning start. When this signal goes ON, movement to the direction specified by DIR(direction signal) with data selected by DSEL0-3(Moving data selection signal) is executed. If SSTOP signal goes ON, decelerated stop is executed.

4.3.1.7. ST_JOG(Jog movement start signal)

This is input signal for jog movement start. When this signal goes ON, movement to the direction specified by DIR(direction signal) with data selected by DSEL0-3(Moving data selection signal) is executed. If signal goes OFF, it stops.

4.3.1.8. DIR(Direction signal)

This is input signal for selection of moving direction. This signal is used to select moving direction for scan movement or jog movement

	Clockwise	Counter clockwise
DIR	OFF	ON

4.3.1.9. SDOWN(Deceleration signal)

This is input signal for deceleration. When this signal goes ON, it decelerates until start speed.

4.3.1.10. SSTOP(Deceleration stop signal)

This is input signal for deceleration stop. When this signal goes ON, it decelerates and stops pulse output.

If this signal goes ON in emergency case, while pulse output stops, ALM output is released.

4.3.1.11. /ES(Emergency stop)

This is input signal for emergency stop. When this signal goes ON, pulse output stops and ALM output turns ON.

4.3.2. Description of SENSOR connector signal

4.3.2.1. HOME(Home sensor signal)

This is input signal for home sensor. This is used for home searching.

4.3.2.2. FOR (Forward limit signal)

This is input signal for forward limit sensor.

While pulse is outputting for clockwise direction, if this signal goes ON, it stops instantly and turns ALM output ON.

4.3.2.3. REV (Reverse limit signal)

This is input signal for reverse limit sensor.

While pulse is outputting for counter-clockwise direction, if this signal goes ON, it stops instantly and turns ALM output ON.

4.3.3. Description of DRIVER connector signal

4.3.3.1. CW+,CW- (CW pulse output signal)

This is output signal for CW pulse of open collector output. In case of 2 pulses mode, this is CW pulse output and in case of 1 pulse mode, this is pulse output.

4.3.3.2. CCW+,CW- (CCW pulse output signal)

This is output signal for CCW pulse of open collector output. In case of 2 pulses mode, this is CCW pulse output and in case of 1 pulse mode, this is direction output.

4.3.3.3. RSCW+,RSCCW- (CW pulse output signal)

This is output signal for CW pulse of line driver output. In case of 2 pulses mode, this is CW pulse output and in case of 1 pulse mode, this is pulse output.

4.3.3.4. RSCCW+,RSCCW- (CCW pulse output signal)

This is output signal for CCW pulse of line driver output. In case of 2 pulses mode, this is CCW pulse output and in case of 1 pulse mode, this is direction output.

4.3.3.5. CO+,CO- (Current-off output signal)

This is output signal for selection of current ON/OFF for stepping motor driver.

4.3.3.6. DIV0-3 (Resolution selection output signal)

This is output signal for resolution selection of NanoDrive stepping driver.

4.3.3.7. HEAT (Driver alarm input signal)

This is input signal for alarm of stepping motor driver. Function selection of System setting can select whether this alarm makes abnormal factor or not.

4.3.4. Description of USB HOST connector/USB DIVICE connector signal

4.3.4.1. VBUS, GND(USB power pin)

This is power pin for USB bus.

4.3.4.2. D-, D+(USB data signal)

This is data signal for USB communication.

5. Parameter

5.1. List of parameter (Movement data)

Item	Range of setting	Factory default	
Movement data 0	Speed range, function setting	0x0000 - 0x03ff	0x0064
	Start speed	0x0001 - 0xffff	0x0001
	Maximum speed	0x0001 - 0xffff	0x0001
	Acceleration ramp	0x0001 - 0xffff	0x0001
	Deceleration ramp	0x0001 - 0xffff	0x0001
	Position data	0x80000000 - 0x7fffffff	0x00000000
Movement data1	Speed range, function setting	0x0000 - 0x03ff	0x0064
	Start speed	0x0001 - 0xffff	0x0001
	Maximum speed	0x0001 - 0xffff	0x0001
	Acceleration ramp	0x0001 - 0xffff	0x0001
	Deceleration ramp	0x0001 - 0xffff	0x0001
	Position data	0x80000000 - 0x7fffffff	0x00000000
Movement data2	Speed range, function setting	0x0000 - 0x03ff	0x0064
	Start speed	0x0001 - 0xffff	0x0001
	Maximum speed	0x0001 - 0xffff	0x0001
	Acceleration ramp	0x0001 - 0xffff	0x0001
	Deceleration ramp	0x0001 - 0xffff	0x0001
	Position data	0x80000000 - 0x7fffffff	0x00000000
Movement data3	Speed range, function setting	0x0000 - 0x03ff	0x0064
	Start speed	0x0001 - 0xffff	0x0001
	Maximum speed	0x0001 - 0xffff	0x0001
	Acceleration ramp	0x0001 - 0xffff	0x0001
	Deceleration ramp	0x0001 - 0xffff	0x0001
	Position data	0x80000000 - 0x7fffffff	0x00000000
Movement data4	Speed range, function setting	0x0000 - 0x03ff	0x0064
	Start speed	0x0001 - 0xffff	0x0001
	Maximum speed	0x0001 - 0xffff	0x0001
	Acceleration ramp	0x0001 - 0xffff	0x0001
	Deceleration ramp	0x0001 - 0xffff	0x0001
	Position data	0x80000000 - 0x7fffffff	0x00000000
Movement data5	Speed range, function setting	0x0000 - 0x03ff	0x0064
	Start speed	0x0001 - 0xffff	0x0001
	Maximum speed	0x0001 - 0xffff	0x0001
	Acceleration ramp	0x0001 - 0xffff	0x0001
	Deceleration ramp	0x0001 - 0xffff	0x0001
	Position data	0x80000000 - 0x7fffffff	0x00000000
Movement data6	Speed range, function setting	0x0000 - 0x03ff	0x0064
	Start speed	0x0001 - 0xffff	0x0001
	Maximum speed	0x0001 - 0xffff	0x0001
	Acceleration ramp	0x0001 - 0xffff	0x0001
	Deceleration ramp	0x0001 - 0xffff	0x0001
	Position data	0x80000000 - 0x7fffffff	0x00000000
Movement data7	Speed range, function setting	0x0000 - 0x03ff	0x0064
	Start speed	0x0001 - 0xffff	0x0001
	Maximum speed	0x0001 - 0xffff	0x0001
	Acceleration ramp	0x0001 - 0xffff	0x0001
	Deceleration ramp	0x0001 - 0xffff	0x0001
	Position data	0x80000000 - 0x7fffffff	0x00000000

	Item	Range of setting	Factory default
Movement data8	Speed range, function setting	0x0000 - 0x03ff	0x0064
	Start speed	0x0001 - 0xffff	0x0001
	Maximum speed	0x0001 - 0xffff	0x0001
	Acceleration ramp	0x0001 - 0xffff	0x0001
	Deceleration ramp	0x0001 - 0xffff	0x0001
	Position data	0x80000000 - 0x7fffffff	0x00000000
Movement data9	Speed range, function setting	0x0000 - 0x03ff	0x0064
	Start speed	0x0001 - 0xffff	0x0001
	Maximum speed	0x0001 - 0xffff	0x0001
	Acceleration ramp	0x0001 - 0xffff	0x0001
	Deceleration ramp	0x0001 - 0xffff	0x0001
	Position data	0x80000000 - 0x7fffffff	0x00000000
Movement data10	Speed range, function setting	0x0000 - 0x03ff	0x0064
	Start speed	0x0001 - 0xffff	0x0001
	Maximum speed	0x0001 - 0xffff	0x0001
	Acceleration ramp	0x0001 - 0xffff	0x0001
	Deceleration ramp	0x0001 - 0xffff	0x0001
	Position data	0x80000000 - 0x7fffffff	0x00000000
Movement data11	Speed range, function setting	0x0000 - 0x03ff	0x0064
	Start speed	0x0001 - 0xffff	0x0001
	Maximum speed	0x0001 - 0xffff	0x0001
	Acceleration ramp	0x0001 - 0xffff	0x0001
	Deceleration ramp	0x0001 - 0xffff	0x0001
	Position data	0x80000000 - 0x7fffffff	0x00000000
Movement data12	Speed range, function setting	0x0000 - 0x03ff	0x0064
	Start speed	0x0001 - 0xffff	0x0001
	Maximum speed	0x0001 - 0xffff	0x0001
	Acceleration ramp	0x0001 - 0xffff	0x0001
	Deceleration ramp	0x0001 - 0xffff	0x0001
	Position data	0x80000000 - 0x7fffffff	0x00000000
Movement data13	Speed range, function setting	0x0000 - 0x03ff	0x0064
	Start speed	0x0001 - 0xffff	0x0001
	Maximum speed	0x0001 - 0xffff	0x0001
	Acceleration ramp	0x0001 - 0xffff	0x0001
	Deceleration ramp	0x0001 - 0xffff	0x0001
	Position data	0x80000000 - 0x7fffffff	0x00000000
Movement data14	Speed range, function setting	0x0000 - 0x03ff	0x0064
	Start speed	0x0001 - 0xffff	0x0001
	Maximum speed	0x0001 - 0xffff	0x0001
	Acceleration ramp	0x0001 - 0xffff	0x0001
	Deceleration ramp	0x0001 - 0xffff	0x0001
	Position data	0x80000000 - 0x7fffffff	0x00000000

Description of Movement data			
	Range of parameter setting		
	Moving to position data	Scanning	Jogging
Speed range / function selection	0x0000 - 0x03ff	same as left	same as left
Start speed	0x0001 - 0xffff	same as left	same as left
Maximum speed	0x0001 - 0xffff	same as left	same as left
Acceleration ramp	0x0001 - 0xffff	same as left	same as left
Deceleration ramp	0x0001 - 0xffff	same as left	same as left
Position data	0x80000000 - 0x7fffffff	Not used	Not used

Remarks;

1. Position data is setting value by numbers of pulses.
 2. Calculation for start speed and maximum value of speed setting ... Value of setting = Frequency[Hz]*N/100 (N=1 - 256)
 3. Acceleration ramp / deceleration ramp ... Value of setting = Ramp[Hz/msec]*N/10 (N=1 - 256)
- (N is value of setting for speed range. However in case of N=256 setting, please set 0 for speed range setting.)

Description for speed range / function selection		
Bit	Item	Value
7:0	Speed range	0x00 - 0xff
8	Selection of coordinates	1: Relative, 0: Absolute
9	Selection of sequential start	1: Valid, 0: Invalid

5.2. List of parameter (System setting)

Item	Description	Setting range	Factory default
Homing speed range / Homing direction setting	This sets speed range for homing and homing direction	0x0000 - 0x01ff	0x164
Homing start speed	This sets start speed for homing.	0x0001 - 0xffff	0x00000000
Homing maximum speed	This sets the maximum speed for homing.	0x0001 - 0xffff	0x0001
Homing acceleration ramp	This sets acceleration ramp for homing.	0x0001 - 0xffff	0x0001
Homing deceleration ramp	This sets deceleration ramp for homing.	0x0001 - 0xffff	0x0001
Waiting time	When homing if moving direction changes, this insert waiting time of setting value * 5msec.	0x0000 - 0xffff	0x0014
Forward limit	This sets software limit for clock wise.	0x80000000 - 0x7fffffff	0x7fffffff
Reverse limit	This sets software limit for counter-clock wise .	0x80000000 - 0x7fffffff	0x80000000
Resolution setting	This sets the selection of resolution.	0x00 - 0x0f	0x00
Selection of function	This sets the selection of function for logic, pulse output and so on.	0x00 - 0x7f	0x00

1. Calculation for homing start speed and homing maximum speed setting ... Value of setting = Frequency[Hz]*N/100 (N=1 - 256)
 2. Calculation for homing acceleration ramp / homing deceleration ramp ... Value of setting = Ramp[Hz/msec]*N/10 (N=1 - 256)
- (N is value of setting for homing speed range. However in case of N=256 setting, please set 0 for homing speed range setting.)

Description for homing speed setting / homing direction setting		
Bit	Item	Value
7:0	Range of homing speed	0x00 - 0xff
8	Homing direction	1: Reverse, 0: Forward

Description of function selection				
Bit	Description	Value		Factory default
		1	0	
0	HOME logic selection	B connection	A connection	0
1	LIM logic selection	B connection	A connection	0
2	HEAT logic selection	B connection	A connection	0
3	Pulse output selection	1 pulse	2 pulses	0
4	Forward direction selection	CCW	CW	0
5	Backlash compensation	Valid	Invalid	0
6	HEAT alarm makes abnormal factor or not.	Make	Not make	0

6. Function

6.1. External start

External start signal(ST_HOME, ST_POS, ST_SCAN, ST_JOG) can execute movement command of movement to home, movement to position, scanning and jogging.

DSEL0 - DSEL3 signals select movement data and DIR specifies the direction of movement.

6.1.1. Timing chart of external signal

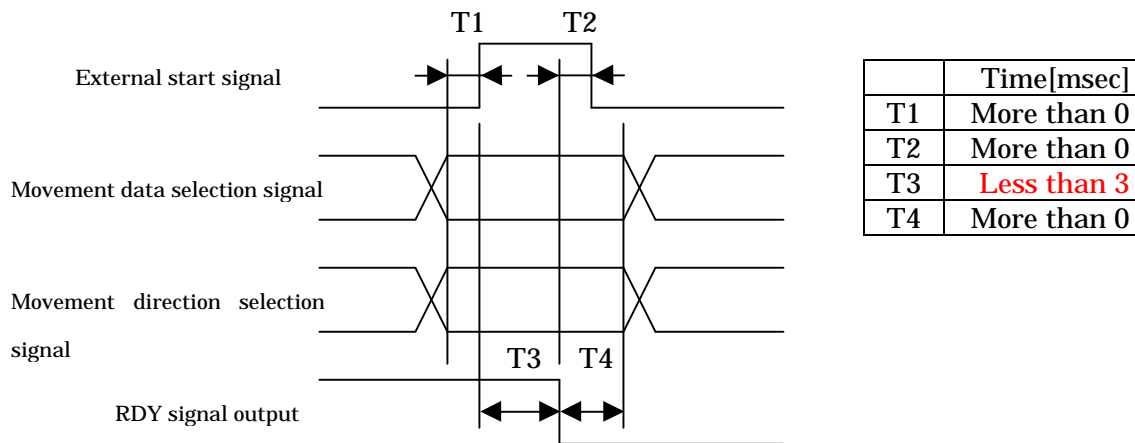

While RDY signal output is ON, signal inputs of ST_HOME, ST_POS, ST_SCAN and ST_JOG are acceptable.

RDY signal output is OFF during activating

6.1.2. Movement data selection signal (DSEL0-3)

This is movement data selection signal to use for position data movement, scanning and jogging.

Please refer the column of DSEL0-3(movement data selection signal) in description of signal with reference to DSEL0-3 and selected position data.

6.1.3. External start signal (ST HOME, ST POS, ST SCAN, ST JOG)

6.1.3.1. ST_HOME(Homing start signal)

Homing is executed when ST_HOME goes ON while RDY signal is ON.

The parameter to use for homing is required to set at CMS-100 in advance.

Movement patterns for homing

Example: Movement of homing to the reverse direction.

(In case of forward direction, forward and reverse is converse.)

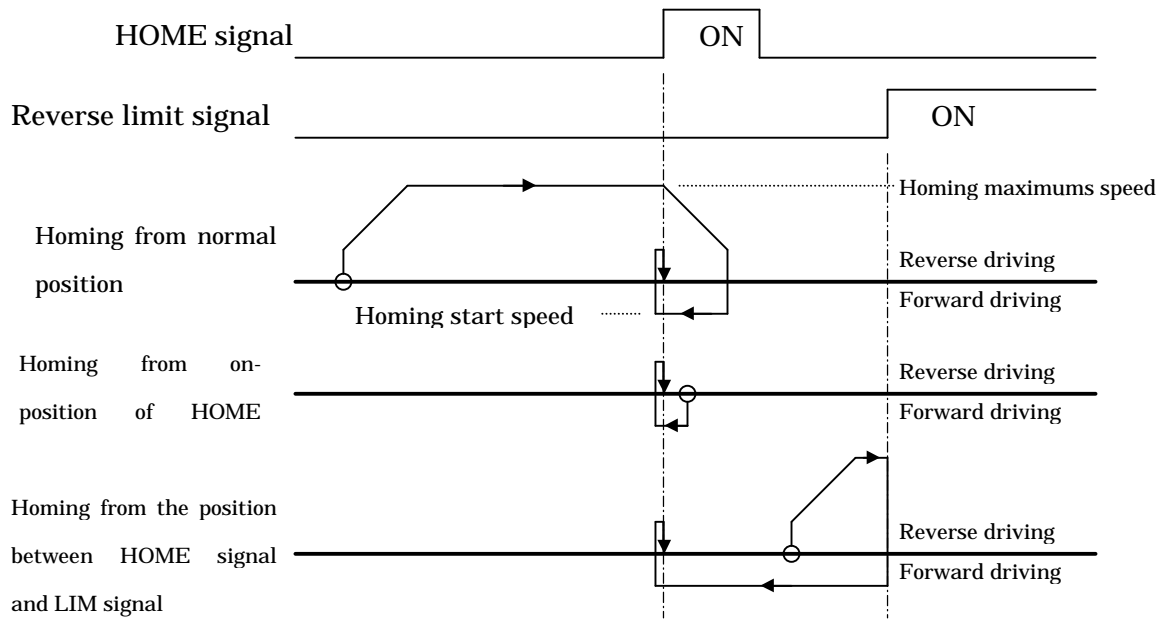

6.1.3.2. ST_POS(Positioning movement start signal)

Movement is executed as target position to the position data of movement data when DSEL0-3 specifies movement data number while RDY signal is ON. The movement data to use for position data movement is required to set at CMS-100 in advance

a. Start by selection of position data

Example movement of positioning movement(Absolute movement)

In case that current position is 1000, the value which is set by position data is 4000 and the setting of coordinates is absolute;

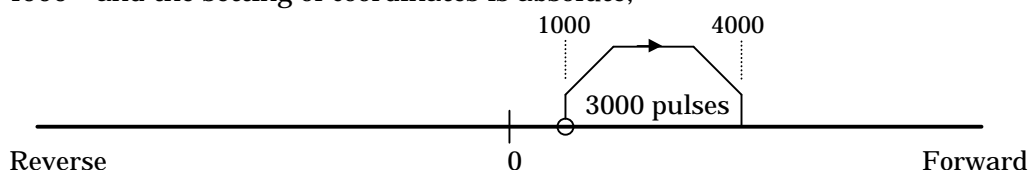

Example movement of positioning movement(Relative movement)

In case that current position is 1000, the value which is set by position data is 4000 and the setting of coordinates is absolute;

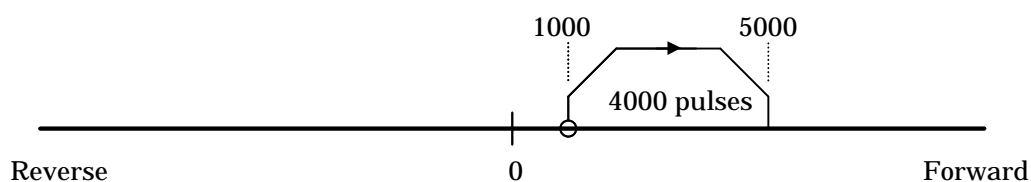

b. Sequential start

In case that all of DSEL0-3 is ON and positioning movement starts, it is sequential start.

In case that DSEL0-3 are ON status, whenever positioning start signal goes ON, valid movement data of 0-14 movement data for sequential start is searched and start is executed.

Searching order of position data is cleared by homing execution.

Example movement of sequential start

Sequential start	Data Number
Valid	0, 5, 6, 10, 14
Invalid	1, 2, 3, 4, 7, 8, 9, 10, 11, 12, 13

If movement data is set as above, movement order is as below.

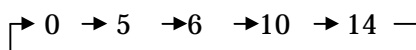

6.1.3.3. ST_SCAN (Scanning start signal)

Scanning is executed when DSEL0-3 specifies movement data number, DIR selects movement direction and ST_SCAN goes ON while RDY signal is ON. Stop is executed when deceleration stop signal (SSTOP) goes ON.

Example movement of scanning

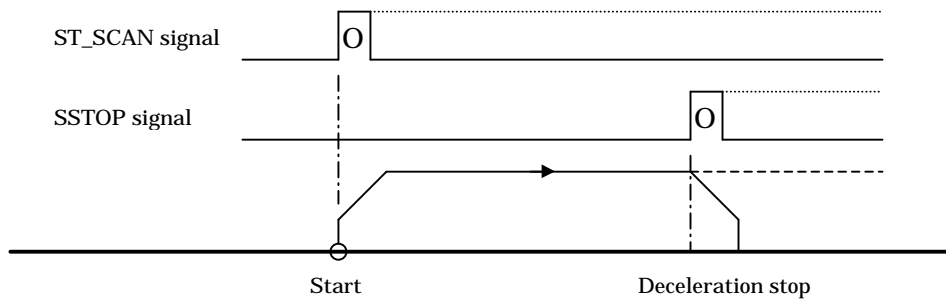

6.1.3.4. ST_JOG (Jogging movement start signal)

Jogging is executed when DSEL0-3 specifies movement data number, DIR selects movement direction and ST_JOG goes ON while RDY signal is ON. Movement continues while ST_JOG is ON.

Example movement of jogging

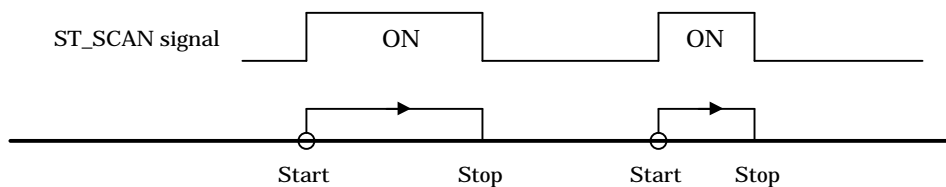

6.1.4. Movement direction selection signal (DIR)

This is movement direction selection signal for scanning and jogging.

Please refer DIR(direction signal) for the movement direction to be selected by DIR.

6.1.5. Deceleration / Stop signal (SDOWN, SSTOP, /ES)

6.1.5.1. Deceleration signal(SDOWN)

This signal decelerates up to start speed when SDOWN signal goes ON during movement.

Example of deceleration

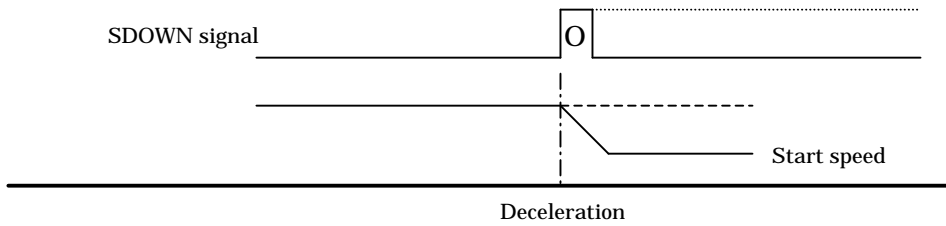

6.1.5.2. Deceleration stop signal(SSTOP)

When SSTOP signal goes ON during movement, deceleration stop is executed and movement is finished.

Example of deceleration stop

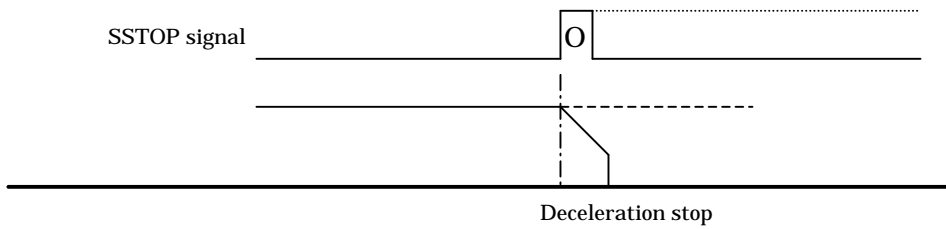

Further more, in emergency case, alarm is released if this signal goes ON when pulse output stops.

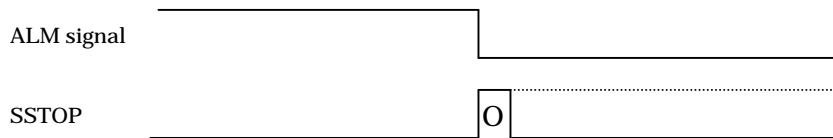

6.1.5.3. Emergency stop signal(/ES)

When /ES signal goes ON during movement, emergency stop is executed and movement is finished.

Example of emergency stop

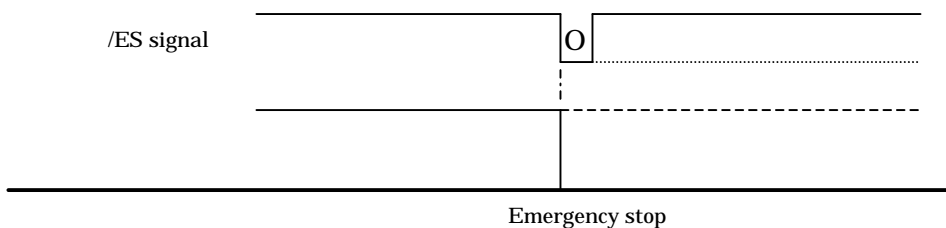

6.2. USB Communication function

Performance of Parameter writing and reading, Status reading, Alarm release, Movement command execution and deceleration stop command execution are available through USB communication.

6.3. Other functions

6.3.1. Function change

6.3.1.1. HOME logic change

Logic of home sensor input (HOME) is changeable.

Bit0 of function change of system setting sets logic. 0 is "A" connection.

6.3.1.2. LIM logic change

Logic of limit sensor (FOR, REV) is changeable.

Bit1 of function change of system setting sets logic. 0 is "A" connection.

6.3.1.3. HEAT logic change

Logic of HEAT signal input is changeable.

Bit2 of function change of system setting sets logic. 0 is "A" connection.

6.3.1.4. Pulse output change

1 pulse or 2 pulse mode is selectable.

Bit3 of function change of system setting sets pulse mode.

Setting value	CW, RS_CW output	CCW, RSC_CCW output
0	CW pulse signal output	CCW pulse signal output
1	Pulse signal output	Direction signal output

6.3.1.5. Forward direction change

Forward direction is selectable.

Bit4 of function change of system setting sets direction. In case of "0", CW direction is forward.

6.3.1.6. Back lash compensation change

Valid or invalid backlash compensation function is selectable.

Bit5 of function change of systems setting sets valid or invalid. "0" is invalid.

The value of backlash is set by homing execution.

6.3.1.7. Selection whether HEAT signal makes abnormal factor or not.

Selection whether HEAT signal makes abnormal factor or not is available.

Bit6 of function change of system setting sets valid or invalid. "0" sets invalid.

6.3.2. Software limit function

There are software limit functions for forward direction and reverse direction.

In case that execution request of movement command which exceeds software limit position, movement is not performed.

The setting range is 0x7ffffff - 0x80000000. However in case that backlash compensation is valid, setting ranges for both ends are smaller for the value of backlash. (In case that backlash compensation is valid and the value is set outside of setting range, software limit is automatically capped.)

7. Example of wiring

7.1. Wiring example with DRIVER connector

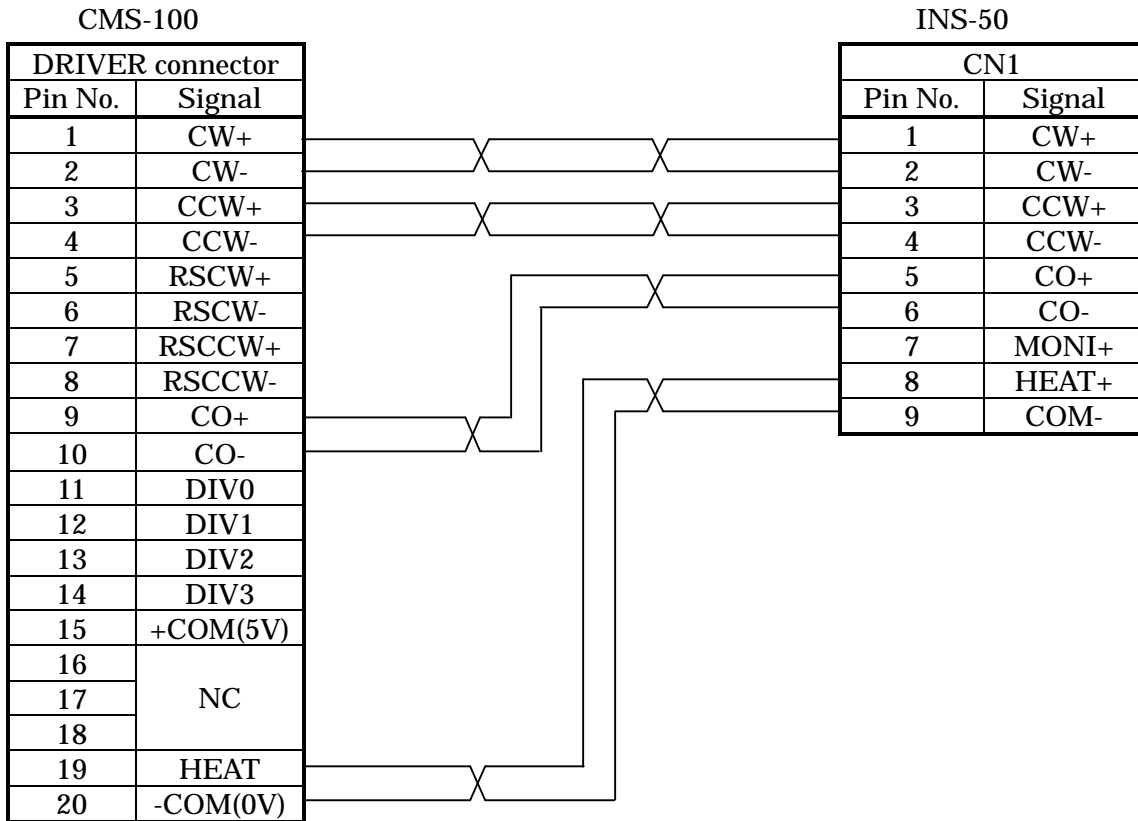

The above figure is wiring example with our INS50 series which is stepping motor driver for NanoDrive.

If in-position signal is managed by external device and external start signal of CMS-100 is controlled, wiring with pulse train servomotor driver is also available.

7.2. Wiring example for SENSOR connector

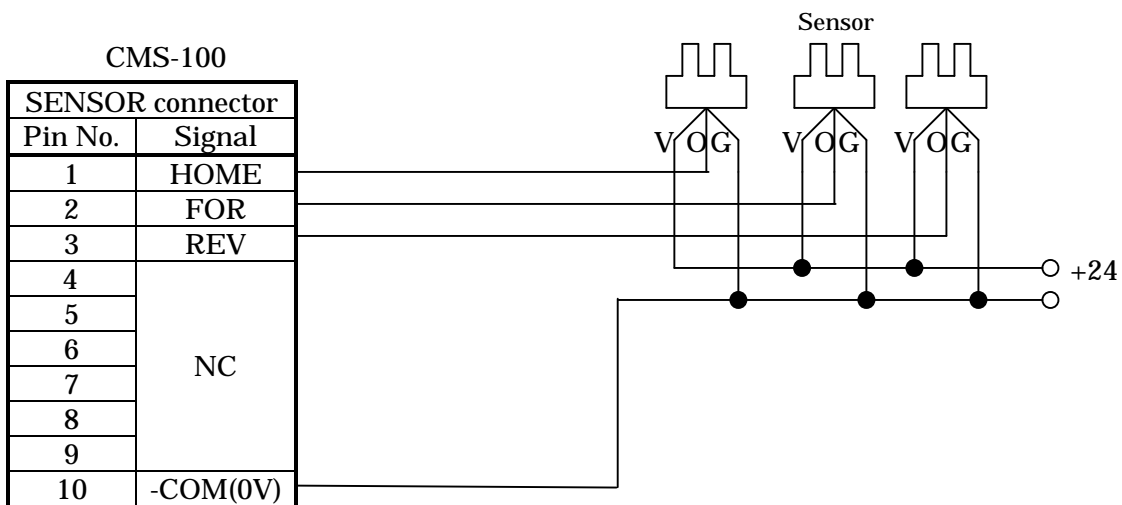

7.3. Wiring example for CONTROL connector

CMS-100

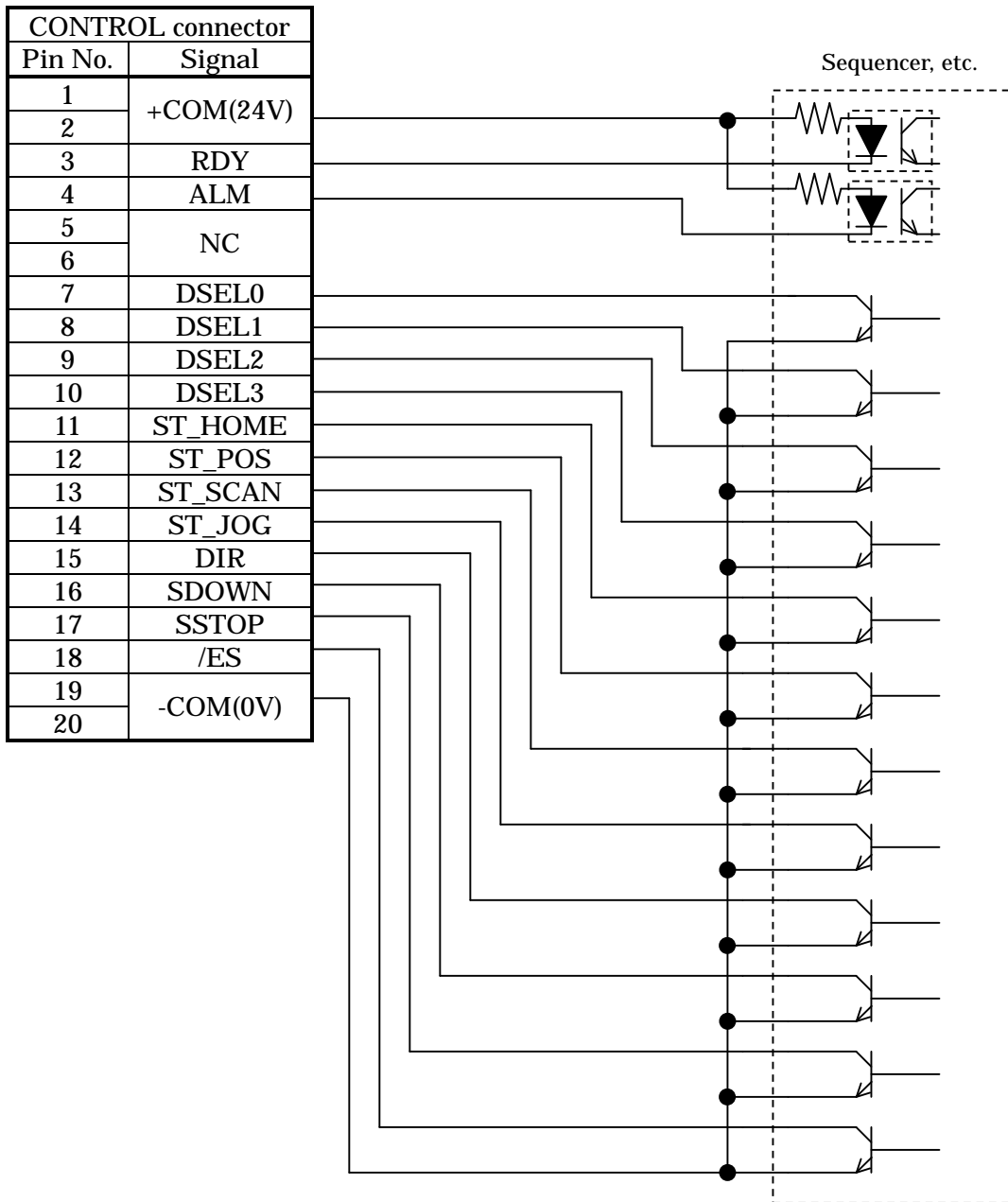

8. List of error code

Error code	Description	Cause and measures
0	No error	---
1	Communication error	Communication error is caused. Please execute the alarm release then execute homing.
2	Emergency stop	Emergency stop signal is inputted. Please execute the alarm release then execute homing.
3	Over-run	Forward/Reverse over-run signal is inputted. Please execute the alarm release then execute homing.
4	HEAT alarm	HEAT alarm is inputted. Please execute the alarm release then execute homing.

9. Appendix

9.1. Communication command

9.1.1. List of command

Group	Command
Parameter reading	Movement data writing command
	Writing of system setting
Parameter writing	Movement data reading
	Reading of system setting
Status reading	Current position reading
	Input signal status reading
	Output signal status reading
	Model code reading
Alarm release	Abnormal status release
Status writing	Current position setting
Movement command	Homing
	Positioning movement
	Scanning
	Jogging
Deceleration stop	Deceleration
	Deceleration stop
	Emergency stop
Current On/Off	Current On/Off

9.1.2. Communication data format

Command	
Byte	Description
1	Command code
2	Number (upper)
3	Number(lower)
4	Data(upper)
5	
6	
7	
8	
9	
10	Data(lower)
11	
12	END Code

Response	
Byte	Description
1	Command code
2	Status
3	Error code
4	Number(upper)
5	Number(lower)
6	Data(upper)
7	
8	
9	
10	
11	
12	Date (lower)
13	
14	END code

*Remarks;
 1. Please transfer or receive number, data, status, error code after chaining into ASCII code.
 2. Please set "0" as dummy data for appointed parts.

Status bit assignment	
Bit	Description
0	Ready
1	On movement
2	Abnormal
3	Alarm(No execution)

Error code	
Code	Description
0	No error
1	Communication error
2	Emergency stop
3	Over-run
4	HEAT

9.1.3. Description of communication data

9.1.3.1. Parameter reading (Movement data)

Command		
Byte	Items	Data
1	Command code	0x80
2	Number (Upper)	Parameter number
3	Number (Lower)	
4	Data(Upper)	Reservation
5		
6		
7		
8		
9		
10		
11	Data (Lower)	0x0d
12	END code	

Response		
Byte	Items	Data
1	Command code	0x80
2	Status	Status
3	Error code	Error code
4	Number (Upper)	Parameter number
5	Number (Lower)	
6	Data (Upper)	Parameter
7		
8		
9		
10		
11		
12		
13	Data (Lower)	0x0d
14	END code	

Description of parameter number			
Upper		Lower	
Items	Value	Items	Value
Movement data number	0 - E	Speed range and function selection	0
		Start speed	1
		Maximum speed	2
		Acceleration ramp	3
		Deceleration ramp	4
		Position data	5

9.1.3.2. Parameter reading (System setting)

Command			Response		
Byte	Items	Data	Byte	Items	Data
1	Command code	0x81	1	Command code	0x81
2	Number(Upper)	Parameter number	2	Status	Status
3	Number(Lower)		3	Error code	Error code
4	Data(Upper)	Reservation	4	Number(Upper)	Parameter number
5			5	Number(Lower)	
6			6	Data(Upper)	Parameter
7			7		
8			8		
9			9		
10			10		
11	Data(Lower)	11			
12	END Code	0x0d	12		
			13	Data(Lower)	
			14	END code	0x0d

Description of parameter number		
Items	Upper	Lower
Homing speed range / Homing direction	0	0
Homing start speed		1
Homing maximum speed		2
Homing acceleration ramp		3
Homing deceleration ramp		4
Waiting time		5
Forward limit	1	0
Reverse limit		1
Resolution setting		2
Function selection		3

9.1.3.3. Parameter writing (Movement data)

Command		
Byte	Items	Data
1	Command code	0x88
2	Number(Upper)	Parameter number
3	Number(Lower)	
4	Data(Upper)	Parameter
5		
6		
7		
8		
9		
10		
11	Data(Lower)	
12	END code	0x0d

Response		
Byte	Items	Data
1	Command code	0x88
2	Status	Status
3	Error code	Error code
4	Number(Upper)	Parameter number
5	Number(Lower)	
6	Data(Upper)	Parameter
7		
8		
9		
10		
11		
12		
13	Data(Lower)	
14	END code	0x0d

Description of parameter number			
Upper		Lower	
Items	Value	Items	Value
Movement data number	0 - E	Speed range / Function selection	0
		Start speed	1
		Maximum speed	2
		Acceleration ramp	3
		Deceleration ramp	4
		Position data	5

9.1.3.4. Parameter writing (System setting)

Command			Response		
Byte	Items	Data	Byte	Items	Data
1	Command code	0x89	1	Command code	0x89
2	Number(Upper)	Parameter number	2	Status	Status
3	Number(Lower)		3	Error code	Error code
4	Data(Upper)	Parameter	4	Number(Upper)	Parameter number
5			5	Number(Lower)	
6			6	Data(Upper)	Parameter
7			7		
8			8		
9			9		
10			10		
11	Data(Lower)		11		
12	END code	0x0d	12	Data(Lower)	
			13		
			14	END code	0x0d

Description of parameter number		
Items	Upper	Lower
Homing speed range / Homing direction	0	0
Homing start speed		1
Homing maximum speed		2
Homing acceleration ramp		3
Homing deceleration ramp		4
Waiting time		5
Forward limit	1	0
Reverse limit		1
Resolution setting		2
Function selection		3

9.1.3.5. Status reading

Command		
Byte	Items	Data
1	Command code	0x90
2	Number(Upper)	Status number
3	Number(Lower)	
4	Data(Upper)	Reservation
5		
6		
7		
8		
9		
10		
11	Data(Lower)	
12	END code	0x0d

Response		
Byte	Items	Data
1	Command code	0x90
2	Status	Status
3	Error code	Error code
4	Number(Upper)	Status number
5	Number(Lower)	
6	Data(Upper)	Status
7		
8		
9		
10		
11		
12		
13	Data(Lower)	
14	END code	0x0d

Description of Status number			
Items	Description	Number	
		Upper	Lower
Current position	This is current position monitor. The unit is "pulse".	0	0
Input signal status	This is status monitor of input signal.		1
Output signal status	This is status monitor of output signal.		2
Model number code	This is model code, version and axis number.		3

Description 1 of status		
Bit	Description of input signal status	Output signal status
0	ST_HOME input signal status	ALM output signal status
1	ST_POS input signal status	RDY output signal status
2	ST_SCAN input signal status	CO output signal status
3	ST_JOG input signal status	
4	DIR input signal status	
5	DSEL0 input signal status	
6	DESL1 input signal status	
7	DESL2 input signal status	

Description 2 of status		
Byt	Model code	Current status
7	Model code	Position data
6		
5		
4		
3	Version	
2		
1		
0	Axis number	

8	DSEL3 input signal status
9	SDOWN input signal status
10	SSTOP input signal status
11	HEAT input signal status
12	ES input signal status
13	FOR input signal status
14	REV input signal status
15	HOME input signal status
16	Deceleration command signal status

9.1.3.6. Alarm release

Command		
Byte	Items	Data
1	Command code	0x98
2	Number(Upper)	Reservation
3	Number(Lower)	
4	Data(Upper)	Reservation
5		
6		
7		
8		
9		
10		
11	Data(Lower)	
12	END code	0x0d

Response		
Byte	Items	Data
1	Command code	0x98
2	Status	Status
3	Error code	Error code
4	Number(Upper)	Reservation
5	Number(Lower)	
6	Data(Upper)	Reservation
7		
8		
9		
10		
11		
12		
13	Data(Lower)	
14	END code	0x0d

9.1.3.7. Status writing

Command		
Byte	Items	Data
1	Command code	0x99
2	Number(Upper)	Status number
3	Number(Lower)	
4	Data(Upper)	Status
5		
6		
7		
8		
9		
10		
11	Data(Lower)	
12	END code	0x0d

Response		
Byte	Items	Data
1	Command code	0x99
2	Status	Status
3	Error code	Error code
4	Number(Upper)	Status number
5	Number(Lower)	
6	Data(Upper)	Status
7		
8		
9		
10		
11		
12		
13	Data(Lower)	
14	END code	0x0d

B

Description of Status number and Description of Status			
Items	Description	Number	
		Upper	Lower
Current position Setting	This is current position Setting. The unit is "pulse".	0	0

9.1.3.8. Movement command

Command		
Byte	Items	Data
1	Command code	0xA0
2	Number(Upper)	Movement command number
3	Number(Lower)	
4	Data(Upper)	Reservation
5		
6		
7		
8		
9		
10	Direction specification	Data number specification
11	Data(Lower)	
12	END code	0x0d

Response		
Byte	Items	Data
1	Command code	0xA0
2	Status	Status
3	Error code	Error code
4	Number(Upper) Number(Lower)	Movement command number
5		
6	Data(Upper)	Reservation
7		
8		
9		
10		
11		
12	Data(Lower)	Direction
13		Movement data number
14	END code	0x0d

Description of movement command number/data				
Items	Movement command number		Direction specification	Data number specification
	Upper	Lower		
Homing	0	0	Reservation	Reservation
Positioning movement		1	Reservation	Movement data number
Scanning		2	Direction	Movement data number
Jogging		3	Direction	Movement data number

Direction: This specifies movement direction. 1=reverse, 0=forward.
 Movement data number : This specifies movement data number for the use of movement command. Numbers are 0 - E.

9.1.3.9. Deceleration / stop command

Command		
Byte	Items	Data
1	Command code	0xA1
2	Number(Upper)	Deceleration / stop command number
3	Number(Lower)	
4	Data(Upper)	Reservation
5		
6		
7		
8		
9		
10		
11	Data(Lower)	
12	END code	0x0d

Response		
Byte	Items	Data
1	Command code	0xA1
2	Status	Status
3	Error code	Error code
4	Number(Upper)	Deceleration / stop command number
5	Number(Lower)	
6	Data(Upper)	Reservation
7		
8		
9		
10		
11		
12		
13	Data(Lower)	
14	END code	0x0d

Description of Deceleration / stop command number		
Items	Deceleration / stop command number	
	Upper	Lower
Deceleration	0	0
Deceleration stop		1
Emergency stop		2

9.1.3.10. Current ON / OFF command

A

Command		
Byte	Items	Data
1	Command code	0xB0
2	Number(Upper)	Reservation
3	Number(Lower)	
4	Data(Upper)	Reservation
5		
6		
7		
8		
9		
10		
11	Data(Lower)	State specification
12	END code	0x0d

Response		
Byte	Items	Data
1	Command code	0xB0
2	Status	Status
3	Error code	Error code
4	Number(Upper)	Reservation
5	Number(Lower)	
6	Data(Upper)	Reservation
7		
8		
9		
10		
11		
12		
13	Data(Lower)	State specification
14	END code	0x0d

State specification	
Current ON	1
Current OFF	0

Please understand that we may make modifications to our products without notification in order to improve the capabilities and external appearance of our products.

For more information

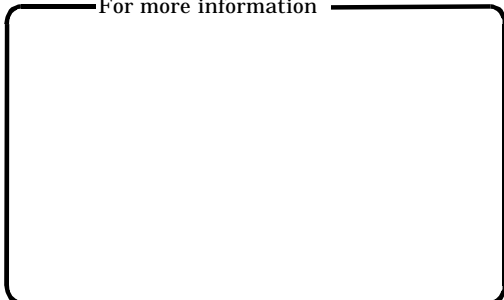

MYCOM, INC.

Head office

12, S. Shimobano, Saga hirosawa, Ukyo, Kyoto, Japan
616-8303

TEL: 075(882)3601

FAX 075(882)6531

Home Page <http://www.mycom-japan.co.jp/>

Sales office Kyoto, Tokyo, Oita

Factory Kyoto

Subsidiary Taiwan, Korea, U.S.A., Singapore, Malaysia

English URL <http://www.nyden.com/>